



ITW Electronic Components FORMEX
 425 North Gary Ave.
 Carol Stream, IL 60188
 Phone: 630-315-2171
 Website: www.itwformex.com

FORMEX™ GK PRODUCT DATA

FLAME RETARDANT POLYPROPYLENE SHEET

TEST METHOD	FORMEX GK-5	FORMEX GK-10	FORMEX GK-17	FORMEX GK-30	FORMEX GK-40	FORMEX GK-62
Color	Black	Natural & Black	Natural & Black	Natural & Black	Natural & Black	Natural & Black
MANUFACTURING SPECIFICATION						
Thickness						
inches	0.005 (+0.001 / -0.001)	0.010 (+0.003 / -0.0015)	0.017 (+0.003 / -0.001)	0.030 (+0.002 / -0.002)	0.040 (+0.002 / -0.002)	0.062 (+0.004 / -0.004)
millimeters	0.127 (+0.025 / -0.025)	0.25 (+0.08 / -0.04)	0.43 (+0.08 / -0.03)	0.76 (+0.05 / -0.05)	1.02 (+0.05 / -0.05)	1.57 (+0.10 / -0.10)
UL FLAMMABILITY RATING / PERFORMANCE LEVELS						
Flammability	UL 94	VTM-0	VTM-0	V-0	V-0	V-0
Relative Temperature Index	UL 746B					
Electrical		115°C / 239°F	115°C / 239°F	115°C / 239°F	115°C / 239°F	115°C / 239°F
Mechanical Without Impact		115°C / 239°F	115°C / 239°F	115°C / 239°F	115°C / 239°F	115°C / 239°F
High Current Arc Ignition - PLC (arcs to ignite)	UL 746A	0	0	0	0	0
High Voltage Arc Tracking - PLC (in / min)	UL 746A	0	0	0	0	0
Hot Wire Ignition - PLC (seconds)	UL 746A	0	0	0	0	0
Comparative Tracking Index - PLC	ASTM D-3638	0	0	0	0	0
TYPICAL MECHANICAL PROPERTIES VALUES						
Tensile Yield - psi	ASTM D-882 / ISO 527-1,-2					
Machine Direction		3,700	4,400	4,400	4,000	4,000
Transverse Direction		3,000	3,200	3,200	3,200	3,700
TYPICAL PHYSICAL PROPERTIES VALUES						
Density - gm/cc	ASTM D-792 / ISO 1183-1, Method A	1.035	1.035	1.035	1.035	1.035
Oxygen Index - %	ASTM D-2863 / ISO 4589--1,-2	29	29	29	29	29
Water Absorption - % Change in weight	ASTM D-570 / ISO 62, Method 4	0.06%	0.06%	0.06%	0.06%	0.06%
Heat Deflection Temperature under load	ASTM D-648 0.45MPa / ISO 75-1,-2, Method B	121°C / 250°F	121°C / 250°F	121°C / 250°F	121°C / 250°F	121°C / 250°F
Surface Energy - dynes / cm (as produced)	ASTM D-2578	≥ 50	≥ 50	≥ 50	≥ 50	≥ 50
TYPICAL ELECTRICAL PROPERTIES VALUES						
Comparative Tracking Index - volts	IEC 60112	600	600	600	600	600
Dielectric Breakdown - volts	ASTM D-149 / IEC 60243-1	11,000	16,264	20,292	29,610	33,380
Dielectric Strength - volts / mil	ASTM D-149 / IEC 60243-1	2,200	1,626	1,194	987	834
Volume Resistivity - ohm-cm	ASTM D-257 / IEC 62631-3-1	3.97 x 10 ¹⁵	3.97 x 10 ¹⁵	3.97 x 10 ¹⁵	3.97 x 10 ¹⁵	3.97 x 10 ¹⁵
Dielectric Constant	ASTM D-150 / IEC 60250, 1MHz	1.90	1.90	1.90	1.90	1.90
Dissipation Factor	ASTM D-150 / IEC 60250, 1MHz	0.0023	0.0023	0.0023	0.0023	0.0023
PACKAGING INFORMATION						
Standard Configuration		Roll	Roll	Roll	Roll & Sheet	Sheet
Core ID - inches (millimeters)		6 (152)	6 (152)	6 (152)	6 (152)	-
Roll OD - inches (millimeters) (approximate)		11 (289)	18 (457)	18 (457)	18 (457)	-
Roll Width - inches (millimeters)		24 (610)	24 (610)	24 (610)	24 (610)	-
Roll Weight - lbs (kgs) (approximate)		57 (26)	198 (90)	178 (81)	192 (87)	-
Length/Roll - feet (meters)		1,000 (304.8)	2,000 (609.6)	1,000 (304.8)	600 (182.9)	-
Area/Roll - square feet (square meters)		2,000 (185.8)	4,000 (371.6)	2,000 (185.8)	1,200 (111.5)	-
Area/Roll - square feet (square meters)		-	-	-	24 x 48 (610 x 1,219)	24 x 48 (610 x 1,219)

Notice: The above data is believed to be accurate and reliable. ITW assumes no responsibility for end-use application, and no performance warranty is expressed or implied. Formex is a registered trademark of ITW. GK is the specific name of our product. Others can not use it without our permission.

ITW Formex[®]

FORMEX™ GK **FLAME RETARDANT** **POLYPROPYLENE SHEET**

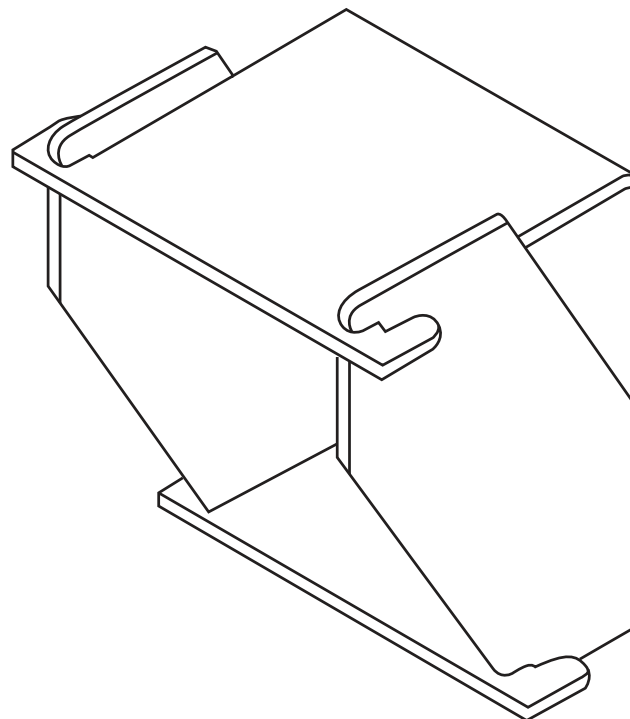
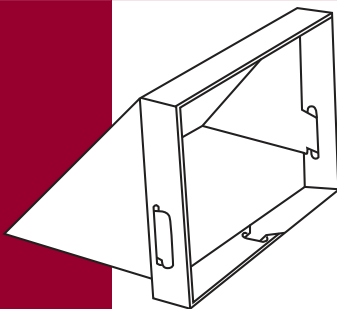
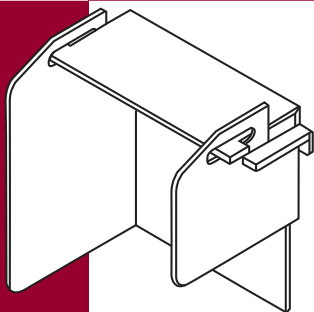
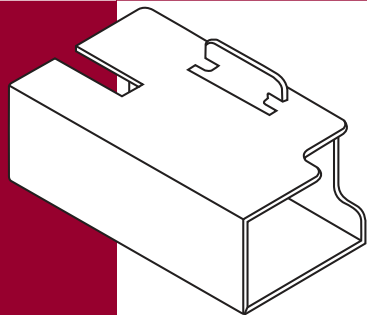

- Flammability Rating UL 94 VTM-0
- H2O Absorption 0.06%
- Temperature Rating 115°C / 239°F
- Dielectric Strength 2,200 Volts / mil @0.005"
- UL Recognized File E121855

For more information or Formex GK samples, please contact us at 630-315-2171.

425 N. Gary Ave. Carol Stream, IL 60188

www.itwformex.com